

# Their Greatest Day:

## *From Disaster to Victory on Omaha Beach*



By John H. Butterfield

**Note:** Allied units are in plaintext; *Axis units are in italics.*

**O**n 6 June 1944, US forces assaulted a stretch of sand held by the Germans on the Calvados coast of France—a shore ever since known by its code name: Omaha Beach. Of the five beaches assaulted by the Allies on D-Day, Omaha was the bloodiest and the hardest-won. For several hours the fate of the invasion hung in the balance on Omaha. Ultimately, the heroism and initiative of the US soldiers prevailed to establish a viable beachhead. It was the greatest day of victory in World War II for the United States, yet Omaha Beach also represented an appalling failure of planning. That plan, developed in such detail, was actually ill-suited to reality.

Omaha Beach commonly conjures images of US infantry struggling from landing craft across the sand, through defensive obstacles and into the teeth of German machineguns; however, tanks, engineers, anti-aircraft, artillery and support troops also landed in the first hours. All had missions to perform, most of which fell by the wayside in the chaos. The various levels of US command on the beach, from generals to junior officers and NCOs, tried to execute the plan, but then had to adapt to its failure in order to go on, recover, and finally achieve victory. In that story lies one of the great controversies of World War II.

A nearly identical plan succeeded brilliantly that same day on nearby Utah Beach. In the case of Omaha, though, the plan was a mismatch to the particular terrain and enemy preparations. What saved the day, then, was the fact the US approach to training officers and enlisted men, and preparing them for battle, produced soldiers who, when faced with failure, took stock of the terrain and the enemy and improvised a victory.

### **Invasion Plan**

In early 1943 the Allies formed COSSAC (Chief of Staff to the Supreme Allied Commander) to plan the invasion of western Europe—Operation Overlord. The invasion was first intended to establish a front in France with secure flanks and sufficient depth to protect it from German counterattack. The Allies would then build up and launch powerful offensive operations across France, with the final objective being Germany itself. Based on the projected available resources, the COSSAC plan called for an invasion of three beaches on the Normandy coast. In January 1944, Gen. Dwight D. Eisenhower was named Supreme Allied Commander, and General Sir Bernard Law Montgomery took command of the invading ground forces. They immediately expanded the plan to include five beaches from the base of the Cotentin peninsula

to the Orne River—over 50 miles of coast. Within that area, Allied planners selected individual invasion beaches code-named Utah, Omaha, Gold, Juno and Sword. The choices all offered flat expanses ideal for assault craft, and were spaced such that landing forces at each one could link up with each other in one day—if things proceeded according to plan. Unfortunately, Omaha Beach was also an ideal place for the Germans to defend against amphibious assault.

The assault on Omaha was assigned to US V Corps under Maj. Gen. Leonard T. Gerow, part of the First Army commanded by Lt. Gen. Omar Bradley. The attack plan called for units of 1<sup>st</sup> Infantry Division, commanded by Maj. Gen. Clarence Huebner, and 29<sup>th</sup> Infantry Division, under Maj. Gen. Charles Gerhardt, to conduct the D-Day assault. The 116<sup>th</sup> Regiment of the 29<sup>th</sup> would land on the west half of the beach, and the 16<sup>th</sup> Regiment of 1<sup>st</sup> Division would go in on the east half. A battalion from each regiment was to land at H-Hour, just after low tide, followed by the other two battalions over the next 90 minutes. Their landings were to be directly supported by DD (amphibious) tanks as well as by conventional tanks landed from assault craft. In addition, a company of Rangers were to land west of the 116<sup>th</sup>.

The infantry landings were to be preceded by an intense air and naval bombardment, with the DD tanks

arriving five minutes before H-Hour to provide immediate fire support. The infantry were to arrive in landing craft that each carried approximately 30 men assigned specific objectives. On the heels of the first wave, engineer demolition teams were tasked with clearing and marking lanes through beach obstacles exposed by low tide to allow safe passage for the later landings during the rising tide. Follow up forces included anti-air, artillery, armor and support troops. Later in the morning two additional infantry regiments were to land to reinforce the push inland.

The plan called for the beach defenses to be neutralized within two hours and the exits from the beaches to be ready for traffic within three hours. At day's end, the Omaha beachhead was to be five miles (eight kilometers) deep, linked with the British who landed at Gold Beach to the east, and prepared to link up the next day with US VII Corps at Utah Beach to the west. All together, over 30,000 men and 3,000 vehicles were to land on Omaha Beach on D-Day.

The plan sought to put overwhelming force on Omaha Beach in a matter of hours, with the objective of eliminating the defense, seizing the local high ground, and establishing a defensive perimeter capable of holding off even a strong enemy counterattack. It looked good on paper.



*Aerial view of Omaha Beach taken just after D-Day, looking north across the bocage toward the beach. The vertical lines indicate draws.*

## Cross-section of Omaha Beach

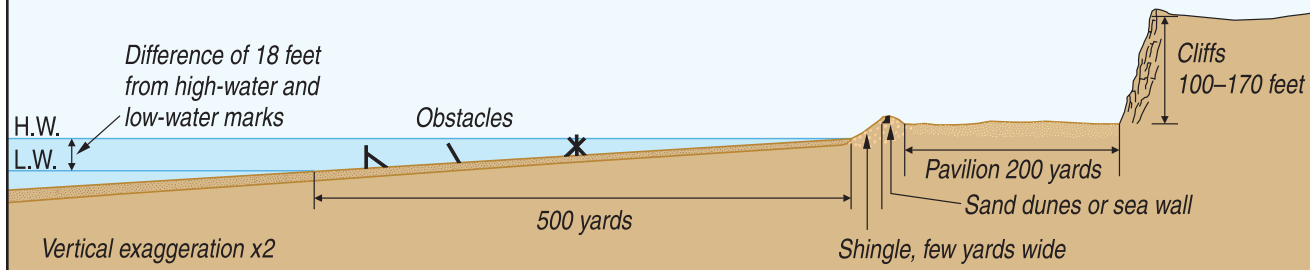

### Battleground

Battle plans are shaped by the terrain of the battleground, and the unique shape and features of Omaha Beach called for a unique plan. Sheer cliffs on both ends framed a sand beach four and a third miles long (seven kilometers) and shaped like a shallow crescent, backed by bluffs and slopes running the length of the beach. Defenders atop those cliffs and bluffs had unobstructed views along the full length of the beach, aided by the gentle concave curve. Taking advantage of that, the Germans set up firing positions at both ends from which to cover the entire beach with overlapping fields of grazing and enfilading fire. Because the positions fired laterally, instead of toward the sea, they could also be concealed and protected from naval gunfire.

On Allied planning maps the beach was divided into alphabetical zones: Charlie, Dog, Easy and Fox. Each zone was further subdivided into colors, such as Dog Green, Easy Red and so on. The beach itself had a gentle slope ranging from 657 yards (600 meters) in depth at low tide to just a few yards at high tide. For an attacker, the best time to land was at high tide to avoid a long beach crossing under fire. Unfortunately, the Germans constructed landing obstacles that were exposed only at low tide and so had to be destroyed before they became submerged and threatened incoming landing craft.

At the top of the beach, running its full length, was the shingle: a slope of loose stone that planners identified as the first line of cover for assaulting troops, providing protection from flat trajectory fire. Along the western half of the beach the shingle was interrupted by wooden and stone sea walls, providing more protection. The shingle had a downside for the invaders—it couldn't be crossed by vehicles until

cleared by engineers. Just beyond the shingle, a narrow stretch of flat and sometimes marshy ground, called the "pavilion," was the last exposed ground the attackers would have to cross before reaching the bluffs, though the occasional beach cottage provided protection (to attacker and defender).

The bluffs, ranging in height from 100 to 150 feet (91 to 137 meters), gave defenders tremendous positional advantage in setting up fields of fire and protected observation points; however, they also limited the defense by denying it depth. No position inland of the bluff could see the beach and vice versa. All German fire on the beach would have to come from the bluff line or below. In addition, the bluffs' folds and gullies offered the attacker avenues of advance to infiltrate the enemy line.

Five draws (narrow valleys) pierced the bluffs, leading inland to the high ground. The Allies named the draws for nearby towns and assigned them code-words: D-1 (Vierville), D-3 (les Moulins), E-1 (St. Laurent), E-3 (Colleville) and F-1 (Cabourg). Roads, mined and blocked by the Germans, led from the beach through the draws to the high ground. Control of the draws was essential to the US plan of getting vehicles off the beach and into the interior. The Germans, of course, understood the importance of the draws as beach exits and so established most of their fortified positions in and around them.

Beyond the bluffs and the draws was the high ground—and another world. Beach and bluff suddenly change to green fields and villages in a quilt of berms and hedgerows, the bocage of Normandy. No one on the beach below could see or conduct lateral fire onto the high ground beyond the bluff, and vice versa, creating two distinct battlefields.

### German Defenses

In late 1943, under the command of Field Marshal Erwin Rommel, the two armies of *Army Group B* initiated improvements to defenses throughout the coast of northern France. In addition to improving fortifications and weapons systems along the coast, Rommel proposed an active defensive strategy based on immediate counterattack. He believed the invasion would have to be defeated at the beach. He therefore advocated placing reserves in operational areas of likely invasion sites, so they could reinforce coastal units and counterattack within hours of an enemy landing. In Rommel's words: *"The enemy is at his weakest just after landing. The troops are unsure and possibly even seasick. They are unfamiliar with the terrain. Heavy weapons are not yet available in sufficient quantity. That is the moment to strike at them and defeat them."*

Rommel believed centrally located reserves farther inland would be unable to reach the beaches until after the Allies had gained the material and manpower advantage. His experience operating in the face of Allied airpower in North Africa convinced him Allied air forces would heavily interdict the movement of more distant reserves. Only local reserves could reach the battle in time. He was, however, alone in that opinion among the German high command. Field Marshall Gerd von Rundstedt, senior commander in the west, and armor expert Gen. Heinz Guderian favored a central reserve, capable of massing armor and attacking when the enemy's intentions were clear. Any given beach landing might prove to be only a diversion, tying up mobile forces while the main thrust developed elsewhere. Guderian believed Allied air supremacy

*continued on page 6 »*

# The Invasion Area, Disposition of German Forces, & Planned Allied Landing Forces

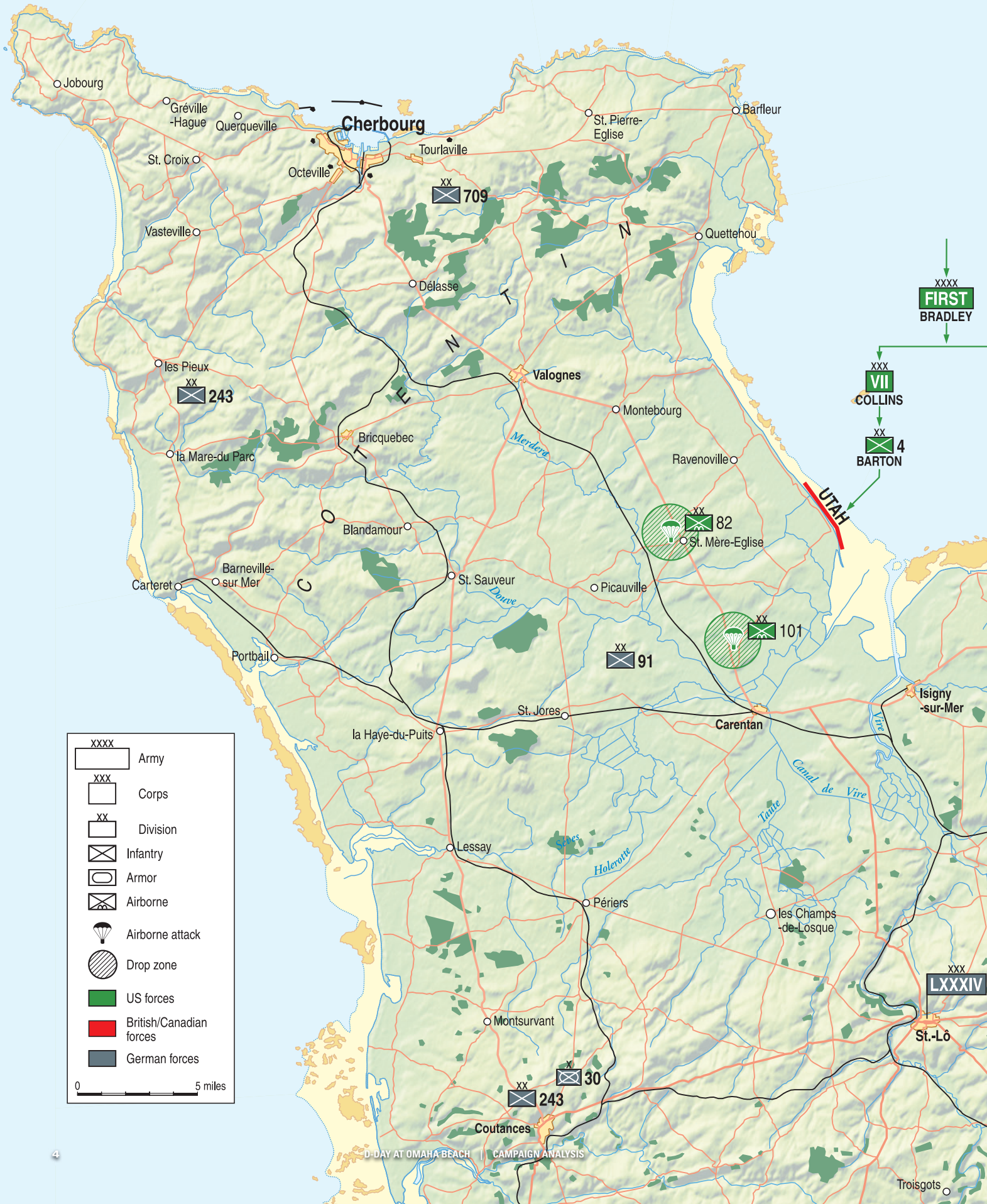

XXXX	Army
XXX	Corps
XX	Division
[Flag icon]	Infantry
[Tank icon]	Armor
[Paratrooper icon]	Airborne
[Paratrooper icon]	Airborne attack
[Circle with diagonal lines]	Drop zone
[Green square]	US forces
[Red square]	British/Canadian forces
[Grey square]	German forces

0 5 miles

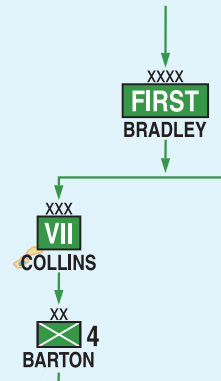

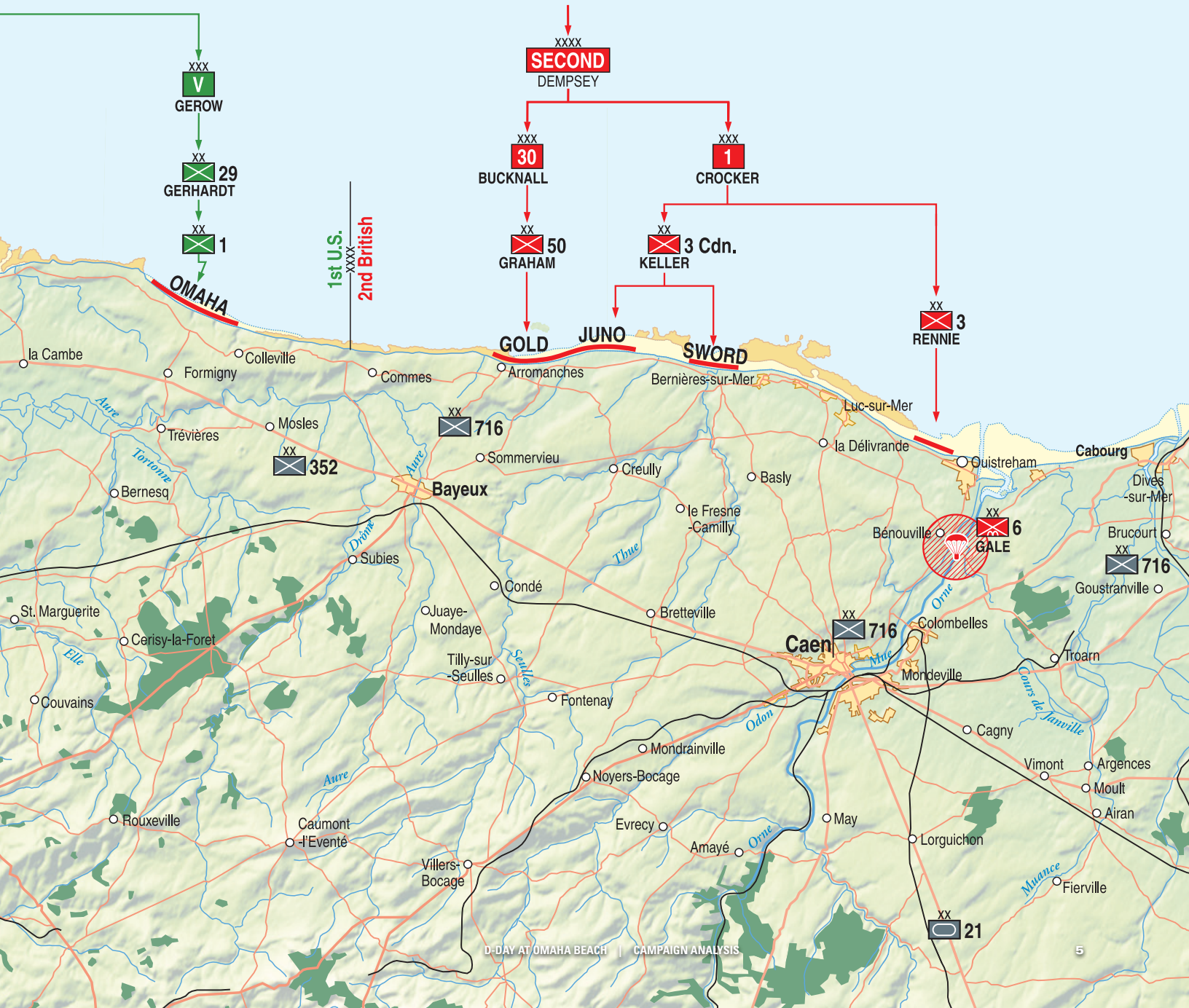
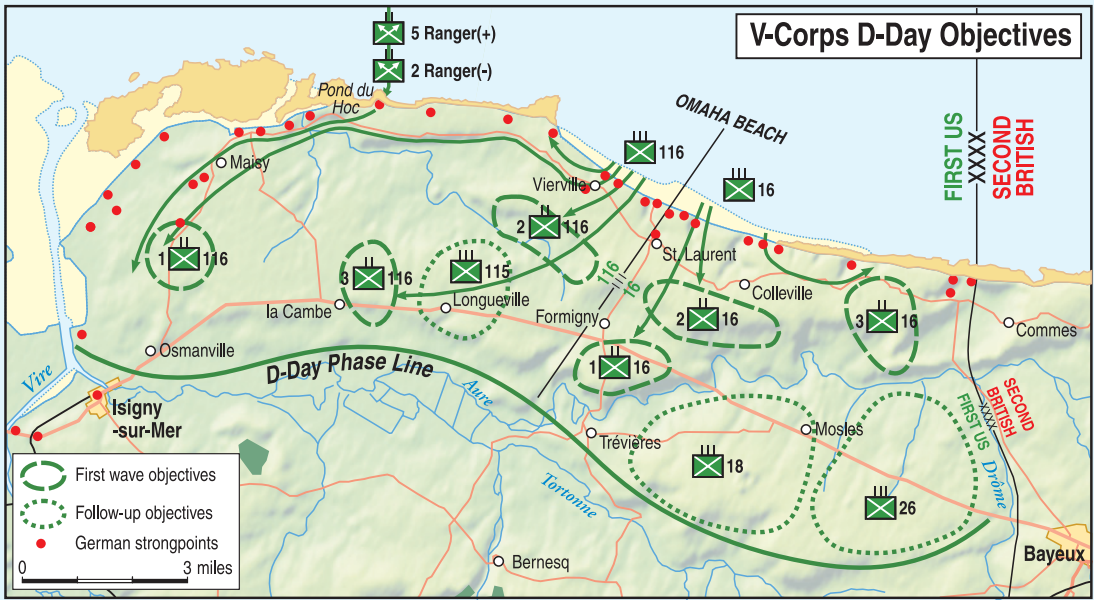

» continued from page 3

could be countered by moving at night. Rommel argued: *“If the enemy once gets his foot in, he’ll put every anti-tank gun and tank he can into the bridgehead and let us beat our heads against it.”*

In the end, then, the German strategy for D-Day came to be a compromise between Rommel’s plan and that of Rundstedt. The armor (*panzer*) divisions were farther from the beaches than Rommel wanted, but he succeeded in moving quality infantry reserves up to the beaches.

That led to the presence of the German 352<sup>nd</sup> Infantry Division at Omaha Beach. According to the US Army’s official history, US intelligence missed the 352<sup>nd</sup> entirely—even though it had been in Normandy for three months before D-Day—and only reported the much weaker 716<sup>th</sup> Infantry Division in the area. Actually, records show US intelligence located the 352<sup>nd</sup> Division some nine miles (15 kilometers) from Omaha Beach weeks before D-Day, and that information was shared with all levels of Allied command. What the Allies didn’t know, however, was two battalions of the 352<sup>nd</sup> had then been moved up to the beach itself. Even so, intelligence on German infantry movement capabilities should have indicated elements of

that division could be at Omaha Beach within three hours of an invasion alarm. The US plan wasn’t modified to take that capability into account, and remained fixed on fighting just the 716<sup>th</sup> Division.

To give teeth to his strategy of defeating the invader at the beach, Rommel also intensified the construction of barriers at all likely invasion sites. At Omaha they took three forms. On the low-tide beaches, mined obstructions would ensnare and destroy landing craft; at the top of the beach, anti-tank obstacles and minefields would prevent movement inland and, overlooking the beaches, concrete fortifications would conceal and protect guns covering every inch in overlapping fields of fire, both lateral and plunging.

On 6 June, the 716<sup>th</sup> and 352<sup>nd</sup> Divisions were thinly spread over a 43 mile (70 kilometer) front. In charge of that sector overall was Maj. Gen. Dietrich Kraiss, commanding officer of the 352<sup>nd</sup>. He deployed five companies from the 726<sup>th</sup> Regiment, 716<sup>th</sup> Division, intermingled with four companies of the 916<sup>th</sup> Regiment, 352<sup>nd</sup> Division at Omaha Beach, most in Widerstandsnester (WN—resistance points) defending the beach. Farther inland, artillery batteries with 105mm and 88mm guns targeted the beach with the aid of forward observers.

## Allied Plan Unfolds

Allied planners knew prepared defenders with the terrain advantages of Omaha Beach could potentially hold off any invasion force thrown against them. To counter, the Allies developed two coordinated plans: the Joint Fire Plan and the Assault Plan.

The Joint Fire Plan, so called because it combined air, naval and ground forces, was developed at the army group and army levels by the staffs of Montgomery and Bradley. It included air bombardment, naval bombardment, and direct fire support by approaching assault craft to prepare the beach and support the assault as soon as it got underway. The Assault Plan, developed at the corps and division levels by Gerow and Huebner, laid out the specific ordering, locations and missions of assaulting forces. Here emerges the key defect in the Allied plans: the objective of the Joint Fire Plan was to suppress and disrupt the enemy at Omaha Beach, and the Assault Plan was then developed based on the assumption the Joint Fire Plan would achieve its objective.

In the Pacific Theater of Operations, extensive bombardment preceded island invasions, subjecting the enemy to a full day or more of pummeling before the ground force hit the beach. Yet the fire plan for Omaha Beach didn’t call for a prolonged pre-invasion bombardment. The reason lies in what waited beyond the beach. In the Pacific, the beach defense was often the entire defense of the island and, even when it wasn’t, the interior of the relatively small islands being assaulted could be targeted with naval gunfire. In France the enemy held reserves inland and demonstrated great skill at employing



ROMMEL VISITING THE ATLANTIC WALL DEFENSES

German Federal Archives

Anti-tank obstacles along the Pas de Calais. Submerged during high tide, one of them could rip open a landing craft with a mine or the steel arm itself.



## Organization of US Forces at Omaha Beach, 6 June 1944

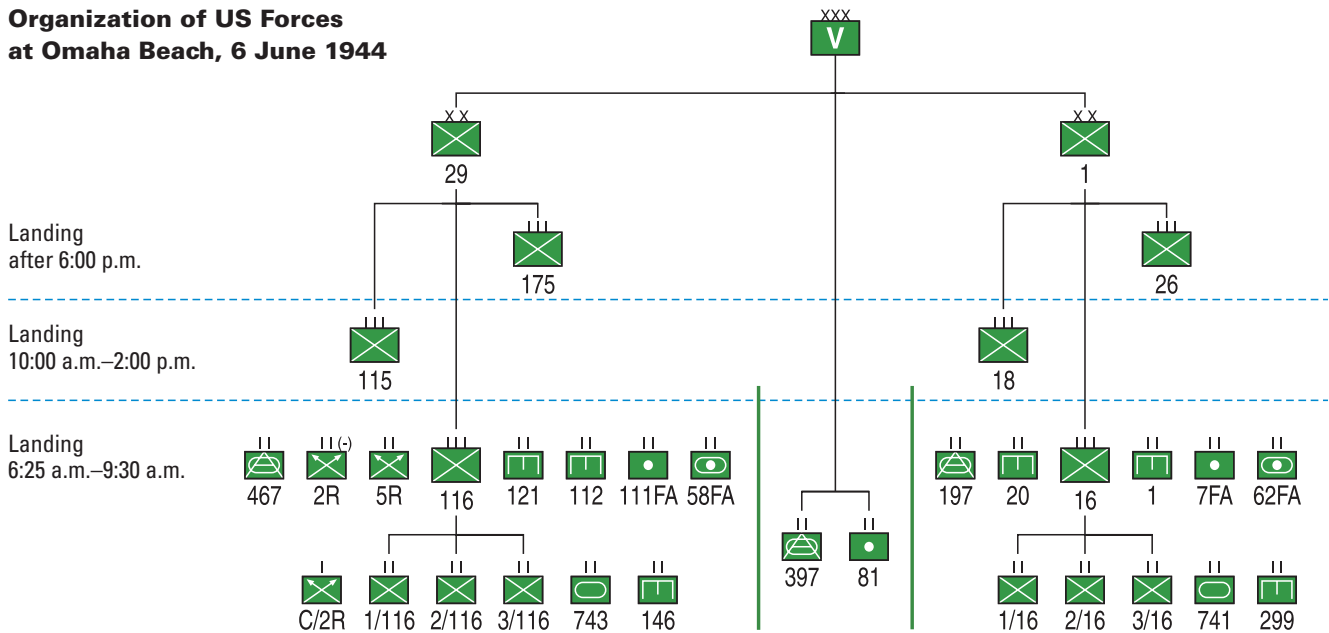

them. Any lengthy bombardment would raise the alarm, with enough time for those reserves to move forward and engage the invaders at the beach. Surprise therefore had to be maintained in order to get ashore before the enemy reserves could deploy. And then there was the situation in the air.

The air portion of the Joint Fire Plan called on the US Eighth Air Force to: 1) establish air superiority; 2) isolate the battle area by interdicting enemy movement and communication; and 3) neutralize the coastal defenses. The first mission was achieved prior to D-Day, allowing concentration on the other missions. The second mission was successfully carried out on D-Day: no German forces transported by vehicles reached Omaha Beach on 6 June. The third mission failed.

Eisenhower, Montgomery and Bradley believed airpower would win the battle, with precision daylight bombardment of the beaches clearing the way for the invaders. That belief was based on misunderstanding the Eighth Air Force's definition of "precision bombing," which was in turn due to the US Army Air Force's (USAAF) own over-reporting of its effectiveness over Germany. To Bradley, precision meant the ability to hit specific structures and positions. To the bomber forces, precision meant putting a bomb in the vicinity of an entire facility, such as a Ruhr factory complex. Precision daylight bombing at that time simply wasn't capable of dependably hitting specific targets on a thin strip of beach.

As it turned out, not a single bomb was dropped on Omaha Beach by the Eighth Air Force on the morning of D-Day. Heavy cloud cover that day meant the bombers had to rely on radar to find targets. Without visual target-sighting, the bombardiers feared hitting the invading troops, and thus delayed their bomb releases a few seconds, resulting in a rain of bombs on the farms inland of the beach.

The naval portion of the Joint Fire Plan called for 40 minutes of intense fire from an Allied flotilla off Omaha Beach. First, counter-battery fire from battleships and cruisers would take out German artillery positions. Then, drenching fire would hit the beach defenses from destroyers and small craft, augmented by that of the large ships after they completed their counter-battery mission. After the first-wave landings, all craft would switch to support-fire called in by naval fire-control parties assigned to the assaulting battalions ashore.

The planners' faith in firepower resulted in the ground commanders preparing to fight the wrong battle, and in the men of the assault force being given a wrong impression of what the battlefield would be like. Word went down that the soldiers approaching the beach would witness, in Bradley's words, "*the greatest show on earth*" as airpower and naval gunfire neutralized the enemy's coastal defense. But the bombers didn't have the technical capability to hit specific targets in overcast conditions, and the large ships

of the bombardment force concentrated against the German big guns, not the beach. Due to the rough Channel waters, the artillery and rockets on the small craft had no way of compensating their aim for the unpredictability of the waves, so most of their fire fell short. The barrage impressed those who witnessed it, but all the fireworks had little impact on the defenses overlooking Omaha Beach. The overall naval fire plan also employed too few ships and too little fire time between first light and troop landing.

Naval bombardment can devastate defensive emplacements, as was shown in the Pacific Theater, and as was demonstrated next door to Omaha Beach. At Pointe du Hoc, the destruction is still visible today in the form of deep overlapping craters and blasted concrete. No such damage is visible on Omaha Beach. Inexplicably, the number of ships assigned to Omaha and Utah beaches were roughly equivalent, despite the fact intelligence estimated the defensive preparations at Omaha were much tougher (even without the battalions from 352<sup>nd</sup> Division). One reason for that was the invasion planners didn't want to risk damaging the exits from the beach, which might slow the movement of vehicles.

The Joint Fire Plan at Omaha Beach called for the early deployment of DD tanks, each launched offshore to navigate to the beach under their own power, with flotation provided by an inflated canvas shroud. Sixty-four DD Tanks of the 741<sup>st</sup>



*A Sherman DD (Duplex Drive) amphibious tank with screen down.*

and 743<sup>rd</sup> Tank battalions were to land just ahead of the first wave of infantry, delivering direct fire against German positions to cover the assault troops' arrival. Those DD tanks were favored over conventional tanks for several reasons. First, they could arrive along the length of the beach, instead of grouped together on landing craft. Second, by approaching the beach individually, DD tanks offered the enemy only small individual targets. Third, the early presence of the DD tanks would provide both a psychological and firepower advantage over the enemy and bolster the confidence of the friendly troops. Fourth, since the existence of DD tanks was unknown to the Germans, those vehicles' unexpected emergence from the surf could be expected to surprise them.

Gerow didn't share the confidence Montgomery and Bradley placed in the DD tanks. Accordingly, his assault plan called for an additional 48 conventional tanks to be brought ashore on landing craft with the first wave of infantry.

Gerow and Huebner were responsible for developing the assault plan, within the parameters of the resources and forces defined by First Army, down to details of how companies were to be divided into boat teams and the weapons they would carry. The assault plan focused on the tactics of where to go and what to attack, based on the assumption the Joint Fire Plan would thoroughly suppress the enemy prior to the assault. As a result, Gerow and Huebner prepared the assault forces to fight the wrong battle.

Three principles drove their assault plan: 1) tactical surprise, to get ashore without forewarning the enemy; 2) concentration of force, to land sufficient men and material to overwhelm the enemy numerically; and 3) speed, to establish a viable defensive perimeter before any enemy counterattack. Accordingly, the assault plan called for direct advances on the draws, with the objective of clearing them in no more than two hours. That would enable the waves that followed to move off the beach immediately on landing.

Four months before D-Day, the Allies became aware of German efforts to fortify the defenses with minefields and obstacles placed beneath the high tide water line, making the beaches dangerous places to land at mid and high tide. Assaulting at low tide took on enormous tactical importance, to avoid the beach obstacles and to land engineers who could remove the exposed obstacles before they became submerged. The beach obstacles presented major planning challenges, affecting the mission of the tanks and introducing teams of combat engineers into the first wave who needed protection so they could destroy the obstacles before the tide rose.

Low tide in early June was at dawn; so Gerow and Huebner favored landing the first-wave infantry in the pre-dawn darkness to gain tactical surprise, to engage the enemy before the engineers landed, and to give the engineers more working time. Landing at low tide also created a tactical problem, as men would have to cross hundreds of yards of open

beach before reaching protective terrain. All that was more reason to land in the dark. Gerow and Huebner didn't get their wish; however, as the timing of the first-wave ended up a compromise between several competing priorities.

The German beach obstacles needed to be removed at low tide, when they were exposed; so the landing needed to be at low tide. The beach obstacles would be exposed from about 6:00 a.m. to 7:30 a.m.

The Eighth Air Force required daylight for precision bombing, which started at about 5:50 a.m. The bombers wanted an hour over their targets, but were given only 40 minutes, from 5:50 to 6:30.

The naval bombardment would likewise be more effective in daylight, operating in the same timeframe as the bombers.

Gerow and Huebner wanted the first wave to land under cover of darkness (prior to 5:50), accepting the risk that night operations tend to be more disorganized and the landing craft would be more likely to miss their specific targets.

The daylight requirements of air and naval fire won out, and the first-wave landings were set for 6:30. As it turned out, then, the infantry got the worst of both worlds. A 6:30 landing meant they would be coming ashore in daylight, but they would still be approaching in darkness, causing many assault craft to go off course.

Once on the beach, the soldiers faced a second line of obstacles in the form of concrete walls, anti-tank ditches and barbed wire. Those obstacles needed to be removed. Bradley believed the precision air bombardment would take out that second line of obstacles. If not, the fire plan called for naval forces and arriving tank and artillery, still in their landing craft, to drench the defenses with direct fire just before the infantry went in. Following that close-in barrage, direct infantry assault would be most effective.

Huebner and Gerow also rejected the tactic of indirect infiltration, which generally worked only at night or in dense vegetation, as practiced in the Pacific. Given their experience and the promise of the Joint Fire Plan, direct assault was indeed the right call. Accordingly, the first-wave soldiers trained to jump off their assault craft in front of the Omaha Beach draws, cross a beach cratered by air and naval bombardment, and take out already suppressed enemy positions.



## LT. SPALDING'S WAR

After 18 months of planning and training, then, at H-Hour, 6:30 a.m. on 6 June 1944, the ramps of the landing craft went down onto Omaha Beach. Among the first to land, A Company of the 116<sup>th</sup> Regiment was on time and on target in front of Vierville draw, on the west end of Omaha Beach. Initially quiet as the Germans waited for more to debark and enter their pre-set fire zones across the beach, the GIs wading ashore wondered, *are the Germans gone?* Then hell was unleashed and all the planning evaporated. But the training survived, and it would be up to the survivors to improvise a new plan. The US victory at Omaha Beach is the story of how that new plan emerged as small groups of soldiers and junior officers found a way.

### 6:25 A.M.

The first landings scheduled, for H-5 minutes, were for the DD tanks of the 741<sup>st</sup> and 743<sup>rd</sup> Tank Battalions. Due to the potential hazards and unknowns of piloting DD tanks in Channel waters, Allied planners wisely left a key decision to the tank company commanders: whether to launch the DD tanks offshore, as planned, to make their way to the beach under their own power or, if conditions were unfavorable, to carry the DD tanks to the beach on their landing craft. For companies B and C of the 741<sup>st</sup> Battalion attached to the 16<sup>th</sup> Regiment, the decision was to launch despite rough seas. That proved a disaster. Even as the first tanks sank, the launchings continued, perhaps attributable to the “can do” attitude of the 1<sup>st</sup> Division. Of the 32 tanks launched, 27 sank. Two made it to the beach on their own, and three were carried in due to launch failure. Conversely, for the commanders of companies B and C of the 743<sup>rd</sup> Battalion attached to the 116<sup>th</sup> Regiment, watching two tanks sink upon launch was enough. They then ordered the landing craft to take the rest of the tanks to the beach. Thirty of 32 tanks made it ashore, 15 minutes late but on target.

The problems with the DD tanks at Omaha Beach have led to the misconception that, with their failure, the infantry lost all tank support. Actually, almost half the DD tanks got ashore, and 32 conventional tanks were carried to the beach with the first wave of infantry.

### 6:30 A.M.

Nine infantry companies, four with the 116<sup>th</sup> Regiment, four with the 16<sup>th</sup>, and one Ranger company constituted the first wave to land on Omaha Beach, aboard 50 landing craft. For those soldiers, survival was primarily a matter of luck. Strong cross currents to the east, darkness, and smoke from brush fires set off by the naval bombardment caused many boats to miss their assigned landing locations. Most of them drifted well to the east of their targets. Those boats that landed directly in front of German strong points suffered the heaviest casualties. Other craft that happened to find gaps between enemy strong points were able to hit the beach unscathed. From such fortunate boats emerged small groups of soldiers that were the first to advance off the beach. Here is how fate played out for the first wave at Omaha Beach, from west to east.

- C Company/2<sup>nd</sup> Rangers (60 men) and A Company/116<sup>th</sup> Infantry (190 men) landed on target in front of the Vierville draw, the most heavily defended on the beach. Half the Rangers managed to

★★★ The initiative of individual junior officers, NCOs and enlisted men won the battle of Omaha Beach, as was exemplified by Lt. John Spalding and his lone boat team from E Company. On reaching the shingle and finding themselves alone, Spalding and his NCO Tech. Sgt. Phillip Streczyk immediately led forward their men. Blasting a gap through barbed wire beyond the shingle with Bangalore torpedoes ①, the team dashed across the flat to the safety of a stone cottage at the base of the bluff, from where they started their climb. Folds in the steep grade afforded protection from a nearby German pillbox. On the way up, the team rushed a machinegun nest and took its lone occupant prisoner, who revealed a German strongpoint firing on the beach was located 656 yards (600 meters) west.

Atop the bluff at 8:00 a.m. ②, Spalding's 21 men were joined by Capt. Dawson and G Company plus a few GIs from two lost boat teams of the 116<sup>th</sup>, who had independently followed a similar route to the high ground. Dawson planned to press on toward Colleville, and he directed Spalding to move against the strongpoint to the west. Following a trench system along the bluff, Spalding's team took out another machinegun position, then came upon an elaborate German dugout network on the east side of St. Laurent draw. The surprised crew surrendered as Spalding's men worked their way through the trenches from the rear. It was 9:30 a.m. and Spalding had taken WN 64 without a casualty ③.

He then turned south to follow G Company to Colleville. Advancing through hedgerow country, the GIs encountered a new kind of fighting—small pockets of experienced German snipers and machinegun crews taking advantage of the bocage. Nonetheless, Spalding's men crossed the farmlands and caught up with Dawson at the south end of Colleville draw, where G company was attempting to advance into the village against a vigorous German defense ④. The commander of 2<sup>nd</sup> Battalion arrived at noon and ordered Spalding's team to the right (south) of the town in an outflanking maneuver. As Spalding moved out, Germans moved into the gap between his team and G Company, and soon Spalding's team was surrounded and under counterattack ⑤. Setting up defensive positions in drainage ditches, his men fought off the Germans all afternoon. Still surrounded and low on ammunition at 7:00 p.m., the team decided to break out for Colleville. Moving through drainage ditches, they made it back to the 2<sup>nd</sup> Battalion outside the village ⑥. Whereupon they were promptly sent back to the right flank to dig in for the night ⑦. ★

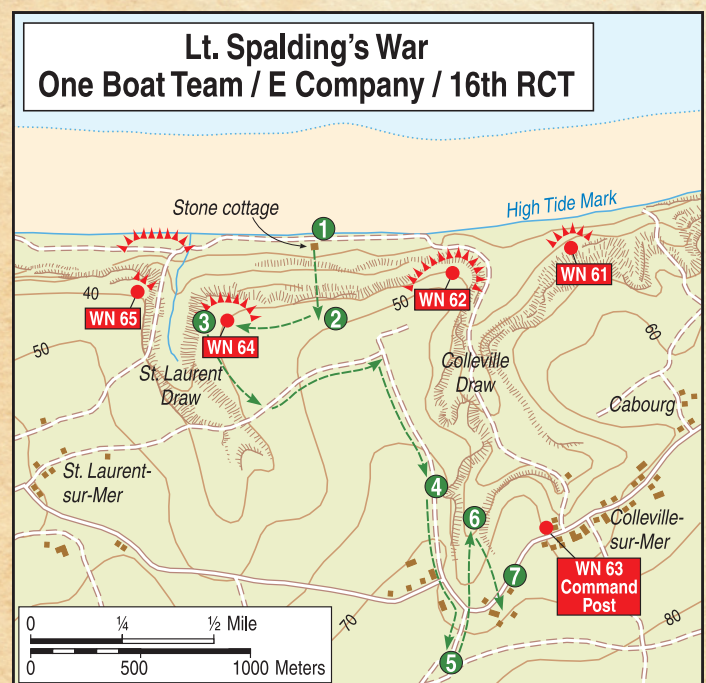

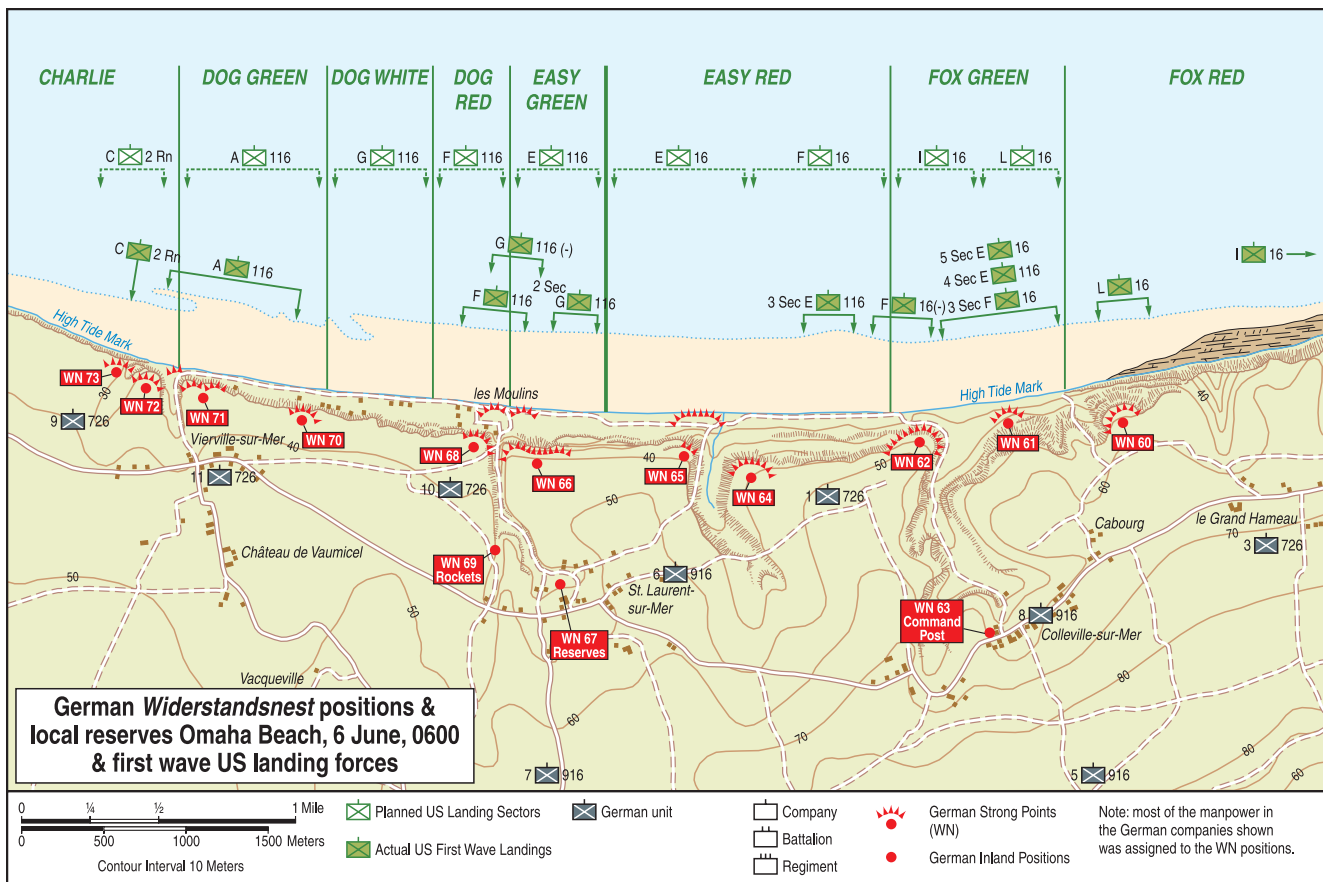

reach the cliffs to the west of the draw. A Company was virtually wiped out.

- The landing target for G Company/116<sup>th</sup> Infantry lay between the Vierville and Les Moulins draws, a lightly defended area. Unfortunately, their boats drifted east and scattered, intermingling with the boats of F Company/116<sup>th</sup>, who landed on target in front of the deadly German positions at Les Moulins draw.
- E Company/116<sup>th</sup> drifted far to the east, scattering into the 16<sup>th</sup> Regiment's sector.
- E Company/16<sup>th</sup> Regiment, scheduled to land in front of the St Laurent draw, traded one hazard for another, drifting east and landing on both sides of Colleville draw. The E Company boats to the east of the draw found themselves under heavy fire, while those to the west happened on one of the seams in the German defense between draws. One fortunate boat from E Company/116<sup>th</sup> found itself in the same location.
- F Company/16<sup>th</sup>, scheduled to land around that same seam, unfortunately drifted east just enough to encounter the intense German fire from Colleville draw.
- L Company/16<sup>th</sup>, delayed by heavy seas, drifted east to relative safety beneath

the cliffs on the far eastern edge of the beach instead of landing in front of Colleville draw.

- Navigational errors sent I Company/16<sup>th</sup> so far to the east it missed the beach entirely and had to make a second run, not landing until 8:00 a.m., after the second wave.

As the men of the first wave crossed the beach under deadly fire, out of contact with other units, with casualties piling up and their objectives nowhere in sight, the mission plan fell away. Only survival remained, and that meant reaching the slanting stone shingle at the top of the beach. Those soldiers who made it there amid the carnage hunkered down and waited for someone to tell them what to do. Whatever they'd been told to do earlier was no longer possible, and many of those not dead or wounded were paralyzed by confusion and shock.

It wasn't the hail of bullets that stopped the US soldiers at the shingle so much as the totally unexpected situation. They'd been told the beach would only be lightly defended by second-rate troops, and even that defense was to have been thoroughly suppressed by air and naval bombard-

ment. They were supposed to charge up the draws and rout out the few survivors, but the beach and bluffs were unmarked except for smoke, and there was nothing second-rate about the German defense.

To the west of the deadly Vierville draw, C Company of the 2<sup>nd</sup> Ranger Battalion stuck to its mission. That unit arrived in only two landing craft, with the mission of advancing up Vierville draw and then heading west to seize the German strongpoint on the promontory of Point de le Percee, west of Omaha Beach. Under fire from the Vierville strongpoints as he crossed the beach to the base of cliffs, Capt. Ralph Goranson appraised the situation and abandoned the planned advance up the draw. He instead began a climb directly up the cliffs, shielded from most enemy fire. In that way his men became the first off Omaha Beach.

### 6:35 A.M.

Among those suffering the heaviest casualties at Omaha Beach were the demolition teams tasked with destroying obstacles in the first half hour of the assault, before the tide rose. Those teams, composed of combat engineers and naval demolition

## GEN. COTA'S WAR

specialists, were to perform their work on the exposed flat of the beach while the first-wave infantry stormed enemy positions that had been disrupted by air and naval bombardment. Tanks were to provide covering fire while the teams worked. There should have been a lot going on to keep German fire away from the engineers, but none of it happened. The exposed engineers were mown down as they attempted to wire obstacles for demolition. Of the nearly 1,000 engineers landing in the first wave, over half become casualties.

Nonetheless, by their determined actions, obstacles were blown and gaps were created. Again, those who landed in the seams between the draws were more likely to survive to fulfill their mission. By the time the tide covered the obstacle belt at 9:00 a.m., gaps had been created and marked in areas between the heavily defended draws. That limited success saved many lives in the later landings, not only due to the removed obstacles, but also because it tended to direct later landing craft to the seams.

### 7:00 A.M.

Landing just 30 minutes after the first wave was the 397<sup>th</sup> Provisional Anti-aircraft Artillery (AAA) Battalion, with crews carrying .50 caliber machineguns and mounts for firing at aerial targets. Their plan was to set up at intervals along the beach to defend against German aircraft attack. No German aircraft attacked Omaha Beach that day. The 397<sup>th</sup> thus became the first of many units whose primary purpose actually seemed to be to give the Germans more targets at which to shoot. Even so, the AAA battalion proved more useful than some units landed later that morning, as a few machineguns managed to set up and put direct fire on German WN positions. That was an improvised mission in support of the infantry assault.

### 7:15 A.M.

The second wave of infantry, four companies each in the 116<sup>th</sup> and 16<sup>th</sup> sectors, landed under fire as heavy as that greeting the first wave, but with the navigational advantage of daylight on their approach. With the terrible carnage now visible on the beach, officers on a few of the incoming craft were able to discern the deadliest areas were in front of the draws. B Company/116<sup>th</sup> benefited from an alert

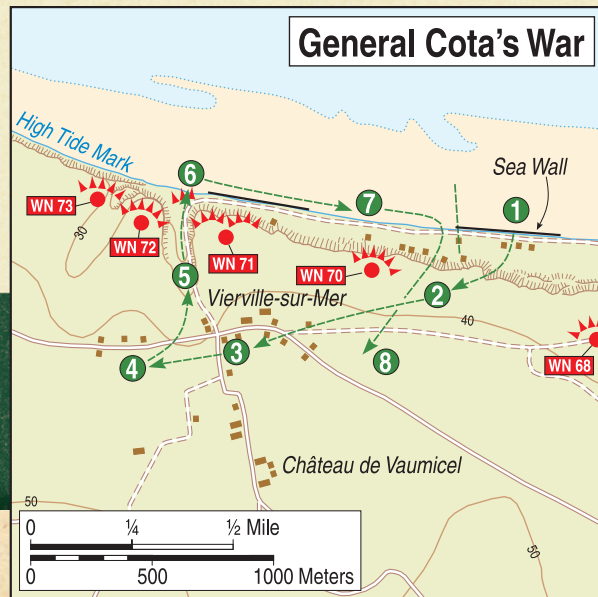

★★★ Among the many individual soldiers contributing to the US victory at Omaha Beach, Brig. Gen. Norman "Dutch" Cota stands out for his audacity and tireless habit of leading from the front. After reaching the safety of the seawall, in the sector where C Company/116<sup>th</sup> had just landed, Cota took in the confusion and paralysis gripping the troops huddled at the top of the beach. He immediately set out to rally men and groups off the beach, strolling among them with the star plainly visible on his helmet ①. Spotting a possible location to cross the open ground between the seawall and the bluff, he crawled forward to scout a position from which covering fire might be provided for the advance and directed a Browning Automatic Rifle (BAR) to set up there.

Some groups on their own, others exhorted by Cota, dared the advance, crossing through barbed wire, over a road, through a second line of barbed wire and into a network of unoccupied German trenches to reach the bluff. Cota joined the climb and reached the top between Vierville and Les Moulin draws at 8:30 a.m. ② He then directed a firefight to clear some Germans out of the hedgerows on the high ground, opening a road toward Vierville. Elements of C Company and other units then advanced cautiously toward the village, expecting strong resistance. Surprisingly, the GIs reached the crossroads in the town center without incident, only to find Cota already there ③. At 10:00 a.m. Vierville was in US hands and any Germans still in the WNs to the north of there were cut off.

Seeking to seize the moment, Cota pushed C Company west and south of the town, but there German resistance suddenly materialized and, making good use of the hedgerows,

stopped the advance. The Rangers joined the effort, heading first south then west in an effort to complete their own mission, but they could make no headway ④.

Cota then decided it was time to clear the draw to the north of Vierville, so vehicles and artillery could get off the beach to help on the high ground. Handing command of the Vierville perimeter to Col. Canham at noon, he and a group of six soldiers headed north from the crossroad toward the beach exit, which was still under German control ⑤. At that time the German positions in and around Vierville draw were subject to intense naval fire. Rattled by the barrage, many Germans were willing to surrender when surprised by US soldiers advancing through the draw from the south. Cota took in the prisoners and continued, despite occasional sniper fire. Those actions ended effective resistance from WNs 71 and 72. Reaching the massive concrete wall at the mouth of the draw, still intact despite the shelling, Cota's team passed through a narrow gap single-file and back onto the beach ⑥. There he handed over his prisoners and set out to get the wall demolished. Informing troops still huddled along the shingle and seawall that the draw was safe, he walked the beach under intermittent enemy fire, locating the men and material needed to do the job—engineers of the 121<sup>st</sup> Battalion and tank dozers carrying crates of TNT ⑦. After setting the demolition mission into motion, he headed back up to the high ground to appraise the situation between St. Laurent and Vierville ⑧. By 3:00 p.m. the wall was blown and engineers worked their way up the draw, clearing out mines and other obstacles. Vehicles began to move up Vierville draw at 5:00 p.m. ★

British commander's decision to shift three landing craft east of their assigned destination at Vierville draw. From those who could see the need for it, a shift in strategy began to emerge: first, land away from the draws, where living soldiers could be seen; then advance up the lightly defended bluffs instead of the draws.

Lt. John Spalding's boat team from E Company/16<sup>th</sup> landed in the first wave in the seam between the Colleville and St. Laurent draws. They were joined there by the newly arriving G Company commanded by Capt. Joseph Dawson. More than 500 yards (456 meters) from the nearest German strongpoint, and further protected by stone cottages and walls, this group also concluded the way off the beach was up the bluffs. They would be the first regular infantry to reach high ground.

Following the second wave of infantry came four more combat engineer battalions, one per draw. The Germans had blocked the beach exits with barbed wire, minefields anti-tank ditches and, at Vierville draw, a concrete wall. All of that had to be cleared before vehicles could get off the beach. Landing on target at their assigned draws, the combat

engineers suffered heavy casualties and weren't able to start their assigned missions for at least three hours. In the meantime, the survivors fought as infantry.

**7:20 A.M.**

An unidentified officer on a control vessel, surveying the grim situation at Vierville draw and the lack of obstacle demolition there, ordered Dog Green Beach closed to further landings. He made the right decision. C Company/116<sup>th</sup> was the first to benefit from it, diverting to the east to land in good order in the relative quiet of Dog White, between Moulins and Vierville draws. There a stone sea wall at the level of the shingle offered protection. Beyond the sea wall and some ruined houses were the bluffs, waiting to be climbed.

**7:30 A.M.**

Support units began to arrive in greater number, in keeping with the plan's timetable. The 81<sup>st</sup> Chemical Mortar Battalion, outfitted with conventional heavy mortars, landed its four companies, one in support of each infantry battalion already on the beach. Their mission was to provide fire support to infantry clearing

the draws and then to deploy on the high ground. The cumbersome equipment was nearly impossible to offload and deploy under the intense fire, much of it sinking in the rising tide. Most mortar crews who survived the landing were forced to abandon their equipment and join the *ad hoc* infantry groups forming at the top of the beach. One crew managed to set up its 300 lb. mortar and fire at a German WN, but the target was too close for the shells' arcing trajectory.

**7:40 A.M.**

A lone landing craft weaving through the undestroyed obstacles in the rising tide made its way to Dog White Beach. Despite striking a pole topped by a mine, the craft was able to disembark its passengers: Brig. Gen. Norman Cota, second in command of the 29<sup>th</sup> Division; Col. Charles Canham, commander of the 116<sup>th</sup> Regiment, and his headquarters staff. Under heavy fire, most of the men made it to the seawall, where soldiers from C Company and other units hugged the breakwater. Gen. Cota immediately set to organizing *ad hoc* teams and ordering groups over the seawall and up the bluffs. In similar

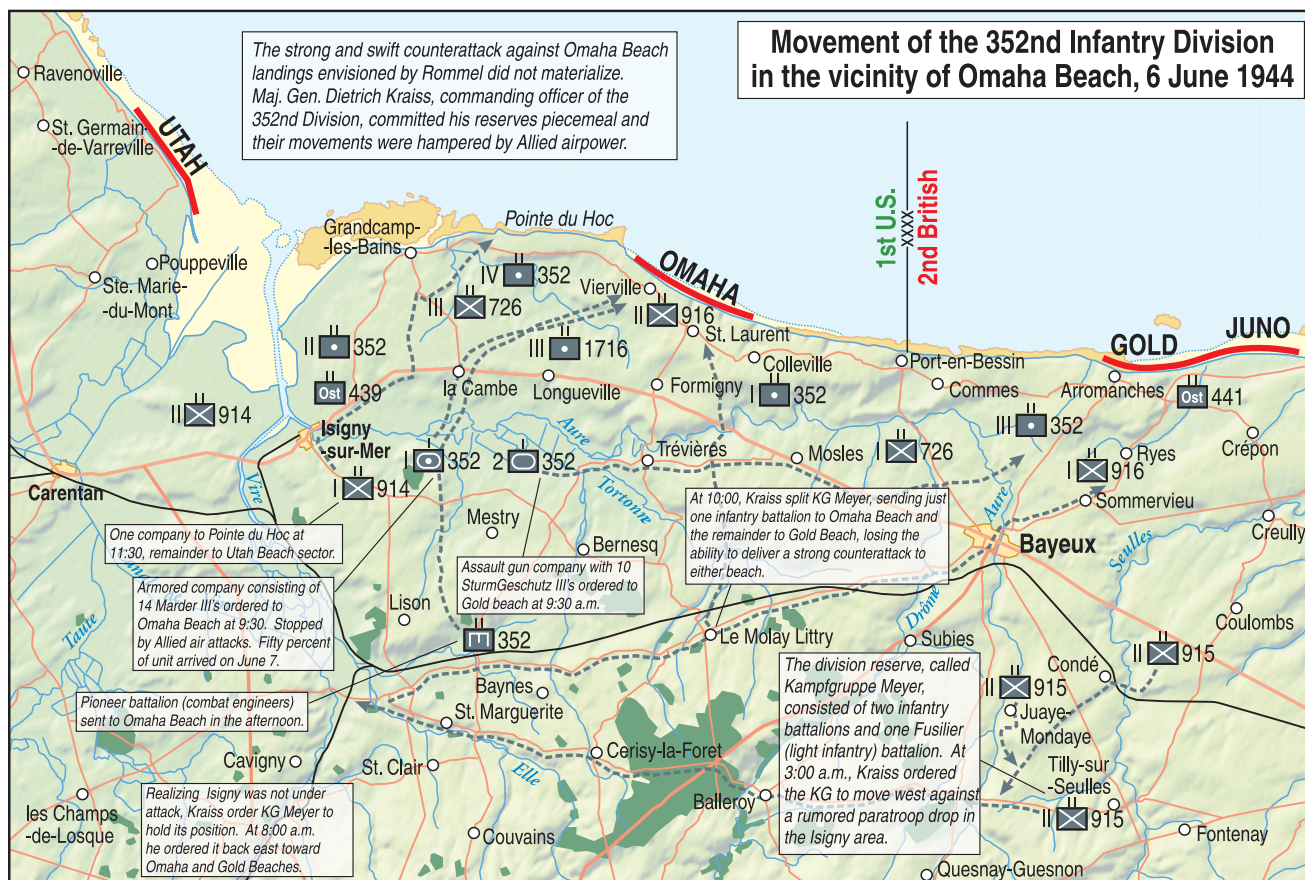

**Evening of D-Day & positions of US forces on Omaha Beach  
6 June 1944**

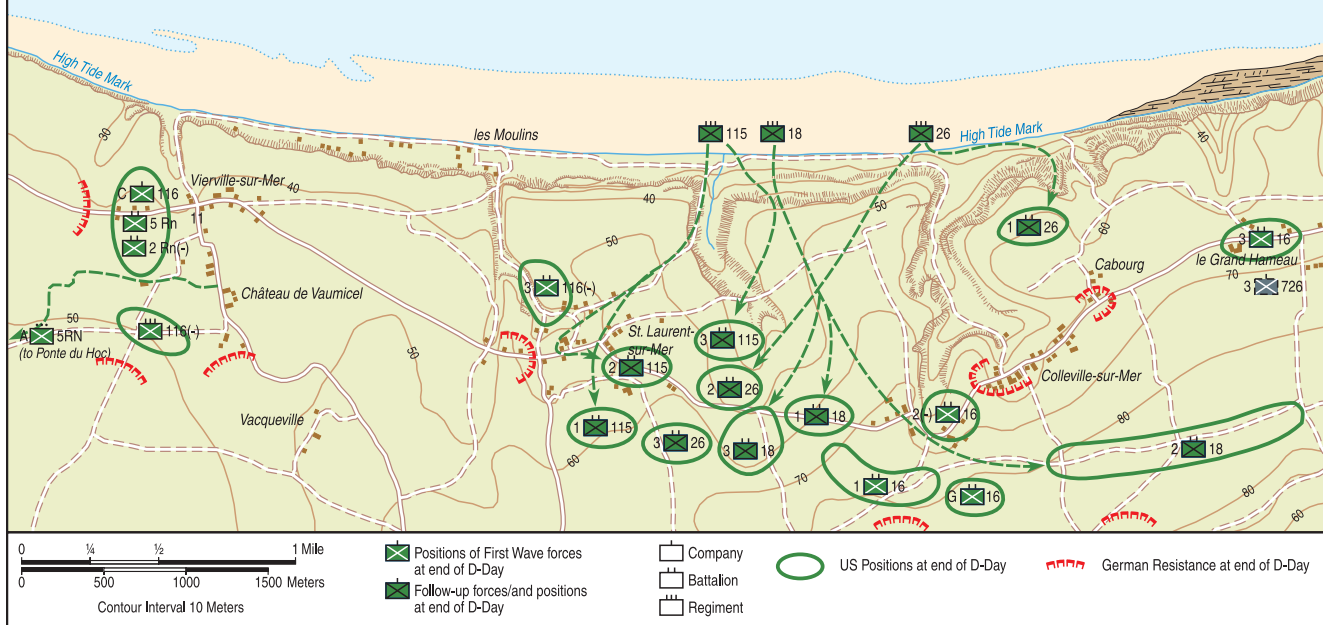

fashion, Col. Canham moved up and down the seawall and shingle with his arm in a sling after being shot through the hand, exhorting men to advance off the beach.

**7:50 A.M.**

When everything seemed to be going wrong on Omaha Beach, fortune delivered unexpected help in the 116<sup>th</sup> sector—reinforcements perfectly suited to deal with the chaos. Eight companies of the 2<sup>nd</sup> and 5<sup>th</sup> Ranger Battalions, totaling over 600 men trained for commando missions, had originally been assigned to a mission at Pointe du Hoc, five miles to the west. Under command of Lt. Col. Max Schneider, that force was to reinforce Pointe du Hoc if signaled the mission there had been successful. When no such signal was received by 7:15 a.m., Schneider switched to plan B: land at Vierville draw and move west overland to rendezvous with his comrades.

As the two companies of incoming Rangers approached Dog Green Beach, they assessed the disaster at Vierville draw and veered to the east, but not quite far enough. Landing in front of WN 70, the 2<sup>nd</sup> Rangers lost half their men before reaching the shingle. The survivors then set out to climb the bluffs and take the position that had cut down their brothers. Rangers from this group are depicted in the film *Saving Private Ryan*.

On witnessing the effect of the German fire on the 2<sup>nd</sup> Rangers, Schneider ordered the craft carrying the 5<sup>th</sup> Rangers to move even farther east, where they landed unscathed in the same area as C Company/116<sup>th</sup>. On reaching the sea wall, Schneider and his Rangers determined their war was starting right there, and organized teams to advance up the bluffs.

**8:00 A.M.**

The third battalion of each assaulting infantry regiment had been told the beach would be clear by the time they came in. Companies I, K, L and M of the 116<sup>th</sup> landed between St. Laurent and Les Moulin draws, an area with few landings up until that time. The units made their way to the shingle, joining a few isolated soldiers from earlier waves. Despite their disorientation, the new arrivals could see that, though they were under fire from German strongpoints to either side, the bluffs straight ahead were only lightly defended and offered relative safety. To the east, Companies A, B C and D of the 16<sup>th</sup> landed between Colleville and St. Laurent draws under similar fire. On reaching the shingle, the survivors attempted to organize. C Company, landing on the stretch of beach just vacated by Spalding and Dawson, spotted encouraging signs that GI's had passed through the area and up the bluff.

According to the plan, it was time for the artillery to begin landing and moving up the draws, to provide support for the infantry against the German counterattack expected on the high ground later in the day. The self-propelled howitzers of the 58<sup>th</sup> and 62<sup>nd</sup> Armored Field Artillery Battalions had provided fire support for the first assault waves from their landing craft offshore. At 8:00 a.m. they were to land and move off the beach. That was not yet possible. The 58<sup>th</sup> delayed its landing until after 10:00 a.m., and even then lost many vehicles on the beach before it was able to advance in the late afternoon. The 62<sup>nd</sup> landed at 3:00 p.m. Neither battalion conducted any land-based fire mission on D-Day.

**8:15 A.M.**

More artillery, the 7<sup>th</sup> and 111<sup>th</sup> Field Artillery Battalions, made their way toward the beach in DUKW (amphibious) trucks, each carrying a 105 mm towed howitzer, its crew and shells. The amphibious trucks fared no better than the DD tanks in the Channel waters. Of the 24 launched, only six guns of the 7<sup>th</sup> FA made it to the beach. On the positive side, they did later manage to exit the beach and had the distinction of conducting the only artillery fire mission on the high ground on D-Day.

BRADLEY ABOARD  
USS AUGUSTA

★★★ Accounts of Omaha Beach often suggest the landings came within a hairsbreadth of evacuation. The source for that belief comes from Gen. Omar Bradley's post-war writings. In them he revealed his state of mind on D-Day morning aboard his command ship *USS Augusta*:

*Our communications with the forces assaulting Omaha Beach were thin to nonexistent. From the few radio messages that we overheard and the firsthand reports of observers in small craft reconnoitering close to shore, I gained the impression our forces had suffered an irreversible catastrophe, that there was little hope we could force the beach. Privately, I considered evacuating the beachhead and directing the follow-up troops to Utah Beach or the British beaches.*

The period from 8:00 to 10:00 a.m. was the most agonizing for Bradley. Little information reached him or Gen. Gerow on the *USS Ancon*. What bits of news did arrive painted a bleak and chaotic picture—nothing hinted at the penetrations onto the high ground already underway. As desperate as things seemed, Bradley kept his thoughts of evacuation to himself; and for good reason: there was no withdrawal plan. The on-scene development of an *ad hoc* plan for an orderly evacuation was out of the question. With no working radios, soldiers beyond the beach couldn't be called back. Insufficient landing craft survived from the morning's carnage to scrape together transport for a full withdrawal. Even if craft had been available, getting men from the protection of the shingle and bluffs back across the beach would've been a deadly undertaking. Only if it became certain the operation was an utter failure, such as at Dieppe in 1942, might an effort be mounted to extract the survivors.

Bradley's other consideration, to reroute reinforcements to neighboring beaches, would have doomed Omaha to failure before it had a chance to succeed—and, despite the bleakness of the information coming in, failure wasn't yet certain. Bradley had to hold at Omaha Beach. Without it, 25 miles would separate Utah and Gold Beaches—a gap far too wide for linking into a viable beachhead. Without Omaha Beach, Fortress Europe couldn't be pierced. Bradley considered those things, but allowed his commanders to command. By 10:00 a.m., regiments released by Gerow were arriving to reinforce Omaha. At the same time, small groups of US soldiers from the first wave were advancing inland and piercing Fortress Europe. ★

Col. George Taylor, commander of the 16<sup>th</sup> Infantry, landed with his staff just west of Colleville Draw. On reaching the shingle, crowded with survivors of the first two waves, he rose and shouted the legendary command: “*Get the hell off the beach! If you stay you are dead or about to die!*”

### 8:30 AM

Armored anti-aircraft artillery arrived to take on the expected *Luftwaffe* strafing of the beaches: the 197<sup>th</sup> and 467<sup>th</sup> Battalions, consisting of heavy machineguns mounted on half-tracks. Half of those armored vehicles survived the landing. Many that did turned nose into the surf, allowing their crews to fire at targets on the bluffs and making important contributions in suppressing fire from German WN positions.

### 8:45 A.M.

To counter the expected German armored counterattack, each regiment's anti-tank company was next on the landing schedule. The few trucks and artillery pieces that managed to land remained under fire on the beach all morning. Several of the AT crews who lost their equipment joined the infantry assault up the bluffs.

Surveying the congestion caused by the rising tide and German fire, Naval beach control officers ordered the suspension of all further landings of vehicles. It would be up to the infantry to clear the beaches before the arrival of heavy equipment would resume. Unknown to the officers observing the apparent disaster from offshore, progress was being made in that regard.

At the western end of the beach, the surviving Rangers of C Company, 2<sup>nd</sup> Battalion had scaled the cliffs west of WN 73, a cliff-top position overlooking most of the beach and delivering deadly fire in front of Vierville draw. Thirty Rangers made it to the top, and were soon joined by a lost boat team from B Company/116<sup>th</sup>. Capt. Goranson's orders were to turn west toward Pointe de la Percee, but seeing the German position firing at GIs on the beach immediately to his east, he attacked there instead, saving innumerable lives. His Rangers advanced past a fortified house and into a labyrinthine German trench system, where they spent the rest of the morning in a running firefight with the enemy. The Germans were able to keep the position occupied until late in the day by using their communication trenches and by pulling soldiers from nearby WN 72, but the pressure from the Rangers halted their fire on the beach. The next day, a body count tallied 69 Germans and two Americans, a testament to the tactical skill of the Rangers.

Farther east, the survivors of A and B Companies, 2<sup>nd</sup> Rangers ascended the bluff below WN 70, between Vierville and Les Moulins draws. Taking advantage of folds in the terrain, the Rangers made it to the crest and cleaned out a network of German trenches and machinegun pits to the east. As German casualties mounted, the remaining Germans surrendered, giving up the position.

### 9:00 A.M.

Gen. Cota's counterpart in 1<sup>st</sup> Infantry Division, Brig. Gen. Willard Wyman, landed between Colleville and St. Laurent draws. His response to the situation was similar to Cota's. In the words of Don Whitehead, a reporter who came ashore with the command party:

*Wyman studied the situation for a few minutes—and then with absolute disregard for his own life and safety, he stood up to expose himself to the enemy's fire. Calmly, he began moving lost units to their proper positions, organizing leadership for leaderless troops. He began to bring order out of confusion and to give direction to this vast collection of inert manpower waiting only to be told what to do, where to go.*

Wyman was encouraged to learn several teams were already advancing on the high ground. Yet he remained anxious about the vehicles under fire on the beach. The draws had to be cleared out to relieve that deadly traffic jam. Though Wyman didn't yet know it, at that hour German positions were starting to crumble from east to west.

WN 61, a massive pillbox located east of the Colleville draw, was one of the first to go, partly due to its location at beach level. F Company/16<sup>th</sup> had been hard hit by that German position, and its survivors were led by Staff Sgt. Frank Strojny. Accompanied by some lost GIs of the 116<sup>th</sup> Regiment, they stormed the position firing BARs and hurling grenades, overwhelming the enemy.

The intrepid actions of L Company/16<sup>th</sup> then took out another WN. Scattered against the cliffs at the eastern extremity of Omaha Beach, the company organized and moved west until the cliffs gave way to an embankment below WN 60. That position had a commanding view of the entire beach and had defensive preparations that made a frontal assault impossible. Covered by suppressing fire from tanks of the 741<sup>st</sup> and the destroyer *USS Doyle*, elements of L Company, led by Lt. Jimmie Monteith, blew gaps through the barbed wire and advanced up a small draw under enemy fire just west of the German position (Cabourg draw, really just a shallow depression in the bluffs). On reaching the high ground, Monteith turned back east and led his men to take the position from behind.

Meanwhile, Lt. Spalding's team was on the high ground, moving against WN 64 (see sidebar). By 9:30 a.m., five of the 11 WN overlooking Omaha Beach were taken, and others were under fire from tanks and naval destroyers.

### **9:15 A.M.**

The third and largest landing of engineers, the 5<sup>th</sup> and 6<sup>th</sup> Engineer Special Brigades, came ashore with the mission of managing the beachhead. That force of 9,000 men included mine clearers, MPs, beach traffic masters, medical specialists, truck drivers—everything needed to run a temporary harbor and supply depot. Vanguards of those brigades had landed with earlier waves, but had been unable to accomplish their advance work. Now the full force came ashore amid confusion and under fire. Tasks relating to the beach itself, such as marking landing sites, could be carried out, but preparing the draws for the flow of traffic still had to wait.

### **9:30 A.M.**

By this time several US units were on the high ground among all the draws, advancing on German positions and moving inland.

- L Company/16<sup>th</sup> was east of Colleville draw.
- G and E Companies/16<sup>th</sup> were between Colleville and St. Laurent draws.
- I, K and L Companies/116<sup>th</sup> were between St. Laurent and Les Moulins draws.
- C Company/116<sup>th</sup> and the 2<sup>nd</sup> and 5<sup>th</sup> Rangers were between Les Moulins and Vierville draws.
- C/2<sup>nd</sup> Rangers and various 116<sup>th</sup> survivors were west of Vierville draw.

Those small forces would need reinforcement to maintain a semblance of a front line as they advanced. Help was on the way.

### **10:00 A.M.—Noon**

Two infantry regiments, the 18<sup>th</sup> of 1<sup>st</sup> Division and the 115<sup>th</sup> of 29<sup>th</sup> Division, were expecting to land on a secure beachhead and move out to seize objectives miles inland. Instead, some found themselves assaulting the enemy on the beach. First to land at 10:30 a.m. was 2<sup>nd</sup> Battalion/18<sup>th</sup> on the west side of St. Laurent draw. Gen. Wyman called for reinforcements there—the first tactical deployment ordered from the beach. WN 64 on the east side of the draw had already been taken by Spalding's team, but the much stronger WN 65 on the west side remained active and untouched. It would be up to 2<sup>nd</sup> Battalion to take it out and open the draw. Practically every service branch contributed to the attack.

As the infantry companies maneuvered to attack the flanks of the WN, the CO of 7<sup>th</sup> Field Artillery rallied men and led frontal assaults; tanks of the 741<sup>st</sup> fired on emplacements; fire from the *USS Frankford* took out a mortar battery, and anti-aircraft guns of the 467<sup>th</sup> neutralized an artillery position. By noon, the draw was in US hands and the 1<sup>st</sup> Engineer Combat Battalion, which also participated in the attack, went to work clearing it for traffic. At 3:00 p.m. the first US vehicle drove off the beach through St. Laurent draw.

Improvisation and courage wasn't practiced only by the soldiers on the beach, but by the naval forces as well. Naval destroyers moved in close enough to get hit by German rifle fire and risk grounding, delivering the equivalent of direct artillery and tank support at great risk. Fire control parties on the beach provided accurate observation for the offshore craft. The effectiveness of the resulting fire proved instrumental in taking out key strongpoints. In some cases that fire alone proved enough to send shell-shocked Germans streaming from their holes to surrender. Omaha Beach was one of the few times in the war naval forces provided direct ground support.

The 115<sup>th</sup> Regiment, earmarked to land behind the 116<sup>th</sup>, was rerouted east between Colleville and St. Laurent draws, landing its three battalions between 11:00 a.m. and noon. The units reached the top of the bluffs in that unfamiliar sector without a mission. Gen. Wyman ordered the three battalions west on a wide front to take the village of St. Laurent. The remaining two battalions of the 18<sup>th</sup> landed in the same area between noon and 1:00 p.m., with orders to advance on Colleville and points south and west of the village.

### **1:00 P.M.—6:00 P.M.**

With eight of 11 German beach positions taken, the focus of the battle shifted to the high ground. The invaders needed the roads leading up from the draws, as well as the connecting coastal highway, for vehicles coming from the beach. That meant taking the villages surrounding those vital crossroads.

The fighting in the villages and bocage of the high ground was a confusing affair with no front line. Units had difficulty staying in contact as they advanced, sometimes finding Germans moving into posi-

tions behind them. The Germans proved adept at setting up machinegun teams in the hedgerows and then disappearing just when they seemed outflanked. Nonetheless, US forces made several penetrations beyond the highway and seized stretches of road. German resistance stiffened at the crossroads, especially in the villages of Colleville and St. Laurent.

After knocking out WN 60, L Company/16<sup>th</sup> and elements of 3<sup>rd</sup> Battalion advanced west and south to secure the flank of the beachhead, defeating one of the few German counterattacks, an attempt to retake the WN from the village of le Grande Hameau.

The remainder of the 16<sup>th</sup>, reinforced by the 18<sup>th</sup> Regiment, made the deepest penetration of D-Day by advancing well south and west of Colleville, effectively surrounding the village. Despite several US attacks, though, the town itself remained in German hands until the next day.

Meanwhile, the most extensive German position, WN 62 on the west side of Colleville draw, fell at 2:00 p.m. Subjected to intense naval fire for hours, it was bypassed and cut off by US infantry on the high ground to the east and west, preventing reinforcement and resupply. With their ammunition depleted and most of their heavy weapons destroyed, the position was abandoned by the few surviving Germans. With WN 62 knocked out, the eastern half of Omaha Beach was secure, and the engineers got to work clearing Colleville draw.

The 115<sup>th</sup> Regiment advanced with difficulty across the rough terrain and woods of St. Laurent draw toward the village of that same name. At 3:00 p.m. the three battalions launched a coordinated assault, attacking the town from the draw, along the coastal highway and in a flanking move to the south. Meanwhile 3<sup>rd</sup> Battalion/116<sup>th</sup>, on the high ground west of Les Moulins draw, battled German forces for the top of the draw. Attacking westward, the GIs won the eastern half of St. Laurent, but the Germans were determined to hold open the road leading south from there, their only escape route.

Only two WN remained active on the beach, WNs 66 and 68 defending Les Moulin draw, a thorn in the side of the invaders for the rest of the day. Elements of the 2<sup>nd</sup> Battalion/116<sup>th</sup> tried unsuccessfully to take WN 66 all morning, but eventually moved up the bluffs toward St. Laurent. No serious attempt was made against WN 68 on the west side of the draw. US forces that reached the high ground west of the position headed toward Vierville. Further, no US reinforcements landed west of Les Moulins, resulting in a thin US presence on the high ground from there to the west end of Omaha Beach. It was all the 5<sup>th</sup> and 2<sup>nd</sup> Rangers and surviving companies of the 116<sup>th</sup> could do to hold open Vierville draw and maintain a line against the German forces west and south of Vierville.

With Les Moulin draw still under German fire, and no US forces to the immediate west of St. Laurent, the

move against the village was limited to frontal attacks, allowing the Germans to stabilize their defense of the town. It would not fall until 7 June.

## Evening

Four US infantry regiments held the high ground across all of Omaha Beach by day's end. The 26<sup>th</sup> Regiment of 1<sup>st</sup> Division came ashore that night, and the 175<sup>th</sup> of the 29<sup>th</sup> the next morning, solidifying the beachhead. Over the next two days, thousands of troops arrived to transform the bloody battleground of Omaha Beach into a temporary harbor and supply head for the massive build up of Allied forces in France.

Any chance the Germans had of winning at Omaha Beach was lost by noon on 6 June. The only units able to respond, the reserves of the 352<sup>nd</sup> Division, were misdirected and committed piecemeal. Rommel was right: the invasion could only be stopped at the beaches. Armored formations that might have rolled over unsupported infantry in the early hours were far from the scene, thanks to the strategic blunders of the high command and to the might of Allied airpower. All day the Eighth Air Force shot up German traffic on the highways leading to Omaha Beach. Once established ashore, the Allied juggernaut couldn't be stopped. The Germans were subsequently able to delay Allied progress on occasion, but the defeat of the *Wehrmacht* in the west became inevitable once the Allies secured the high ground at the invasion beaches. ★

## SOURCES

Ambrose, Stephen E. *D-Day June 6, 1944*. New York: Simon & Schuster, 1994.  
Balkoski, Joseph. *Omaha Beach: D-Day June 6, 1944*. Mechanicsburg, PA: Stackpole Books, 2004.  
Bernage, Georges. *Omaha Beach*. Bayeux, France: Heimdal, 2001.

Pogue, Forrest C. *John Spalding D-Day narrative*. Military History Institute, Carlisle Barracks, Pennsylvania).  
Harrison, Gordon. *Cross Channel Attack*. Washington, DC: Chief of Military History, 1951.  
Lewis, Adrian. *Omaha Beach: A Flawed Victory*. Chapel Hill: University of NC, 2001.

Zetterling, Niklas. *Normandy 1944, German Military Organization, Combat Power and Organizational Effectiveness*. Winnipeg, Manitoba: J.J. Fedorowicz, 2000.

*Various official reports of the actions of the 16<sup>th</sup> Infantry Regiment on D-Day*, transcribed on the web site [www.warchronicle.com/16th\\_infantry/contents.htm](http://www.warchronicle.com/16th_infantry/contents.htm).



*Omaha Beach transformed from a battle ground to a harbor in a matter of days.*